

AS1

The photoelectric light grids of the **AS1** series are **crossed-beam area sensors** able to detect all objects, with even 0.2mm thickness, inside a 100mm height, over operating distances reaching 3m between emitter and receiver.

The **AS1** area sensors represent the ideal solution for the detection of very small objects, even when passing in different positions inside the controlled height and width.

Version with **trimmer adjustment and optic synchronism** between emitter and receiver unit are available.

The distance between emitter and receiver can range from 0.3 up to 2.1 m for the **AS1-LD** models and from 0.8 up to 3 m for the **AS1-HD** models.



SENSORS

HIGHLIGHTS

- Crossed beam area sensors
- 100mm controlled height
- Operating distance reaching 3m
- Adjustment trimmer
- PNP output
- Optic synchronism (trimmer models)
- Scan Mode input (HR models)

APPLICATIONS

- Object presence/absence control
- Object counting
- Object passage control on conveyor lines

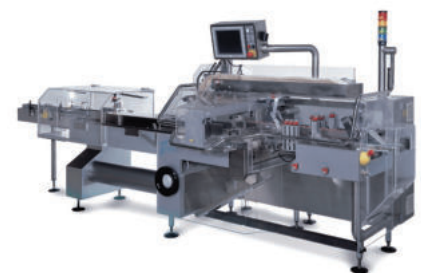

Two different models are available: **high resolution (AS1-HR)** or **standard resolution (AS1-SR)**. In the first case the light array has 16 beams, while in the second case the beams are reduced to 6. In the AS1-HR model, the selection inputs of the SCAN MODE, can configure 4 different crossed-beam scanning modes. These different modes allow to vary the detection performances, in particular the resolution can be increased to 0.2mm thickness, or the response time up to less than 3ms.

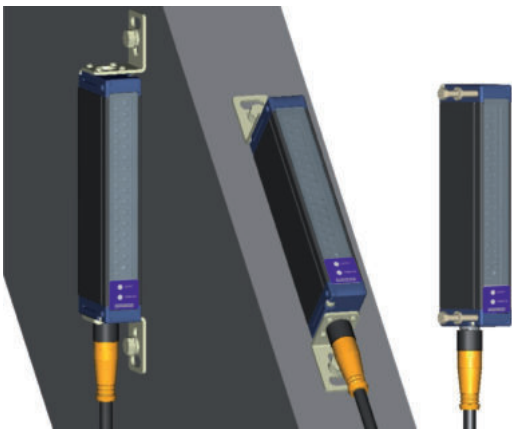

DIMENSIONS

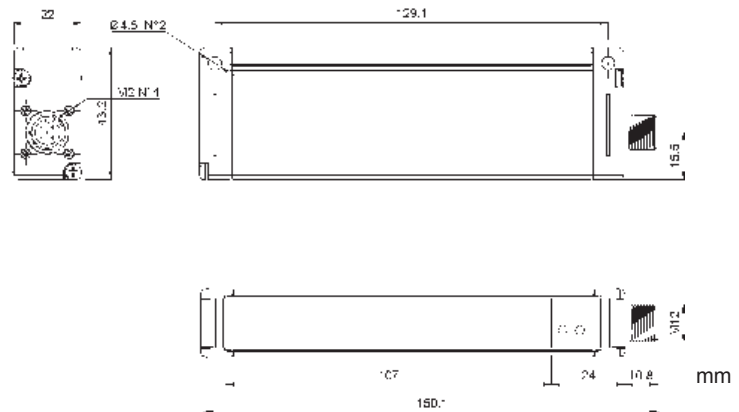

INDICATORS AND SETTING (TRIMMER VERSIONS)

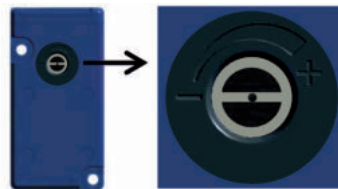

Emitter is equipped with a manual regulation which lets the user change the emission power by means of a screwdriver. The emission power reduction can be particularly useful to lower passive reflections when maximum operating distance it is not required.

CONNECTIONS

RECEIVER (RX)

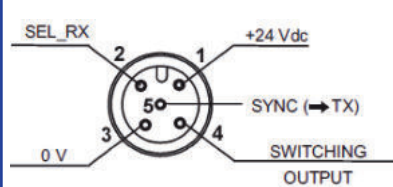

EMITTER (TX)

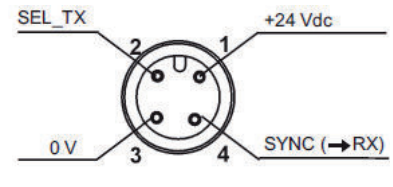

1	=	brown	=	+24Vdc
2	=	white	=	SEL_RX (only AS1-HR)
3	=	blue	=	0 V
4	=	black	=	SWITCHING OUTPUT
5	=	grey	=	SYNC

1	=	brown	=	+24Vdc
2	=	white	=	SEL_RX (only AS1-HR)
3	=	blue	=	0 V
4	=	black	=	SYNC

FIXING BRACKET

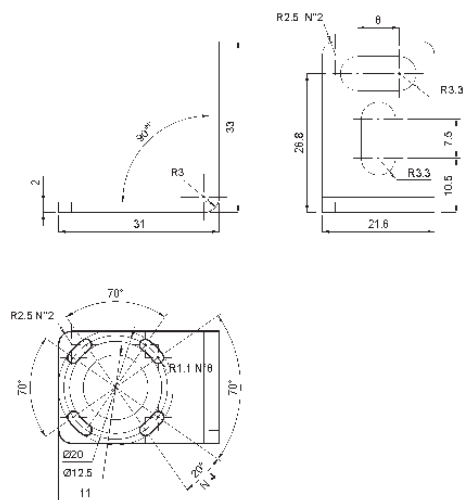

TRIMMER VERSIONS

RECEIVER (RX)

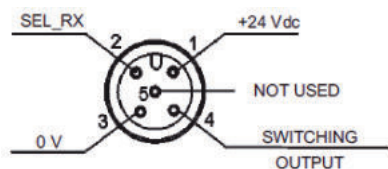

EMITTER (TX)

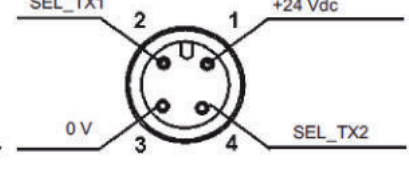

1	=	brown	=	+24Vdc
2	=	white	=	SEL_RX (only AS1-HR)
3	=	blue	=	0 V
4	=	black	=	SWITCHING OUTPUT
5	=	grey	=	SYNC

1	=	brown	=	+24Vdc
2	=	white	=	SEL_TX1 (only AS1-HR)
3	=	blue	=	0 V
4	=	black	=	SEL_TX2 (only AS1-HR)

TECHNICAL DATA

Power supply:	24 Vdc ± 15 %
Consumption on emitting unit:	150 mA max.
Consumption on receiving unit:	40 mA max. load excluded
Outputs:	1 PNP output
Load current on PNP output:	100 mA; short-circuit protection
Saturation voltage on PNP output:	≤ 1.5 V at T=25°C
Emission type:	infrared 880 nm
Response time:	1,75 ms (AS1-SR vers.) 2,75 - 8 ms (AS1-HR vers.)
Optics number:	6 (AS1-SR vers.) 16 (AS1-HR vers.)
Resolution:	refer to tables
Operating distance:	0.3 – 2.1 m (AS1-LD) 0.8 – 3 m (AS1-HD)
Receiver indicators:	green POWER ON LED yellow OUT LED
Emitter indicators:	green POWER ON LED
Functioning temperature:	0 ... + 50 °C
Storage temperature:	- 25 ... + 70 °C
Humidity:	15...95 % (uncondensed)
Mechanical protection:	IP65
Housing material:	aluminium
Optics material:	PMMA
Connections:	M12 4-pole connector (TX) M12 5-pole connector (RX)
Weight:	300g

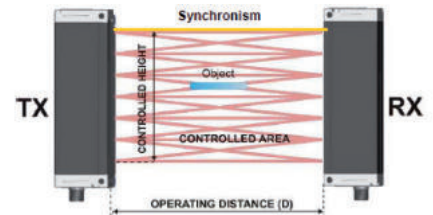

HIGH RESOLUTION SCANNING MODE

PROG. N°	SEL_RX	SEL_TX	RESOLUTION	RESPONSE TIME (msec)
1	0 Vdc or FLOAT	0 Vdc or FLOAT	LOW	2.75
2	0 Vdc or FLOAT	24 Vdc	M/L	3
3	24 Vdc	0Vdc or FLOAT	M/H	7.75
4	24 Vdc	24 Vdc	HIGH	8

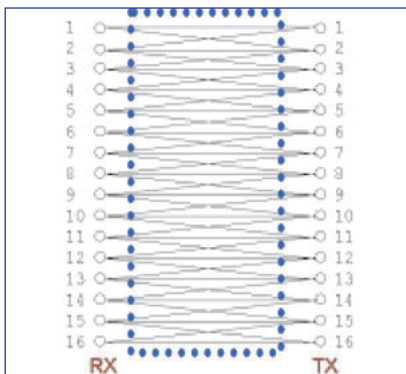

Scan mode 1:
high speed / low resolution
Minimum object detection
Flat = 0.4 (thickness) x 100 (width) mm
Cylindrical objects = Ø 6 mm

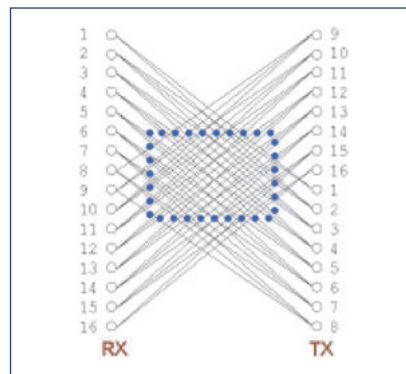

Scan mode 2:
high speed / mid resol. central area
Minimum object detection
Flat = 0.4 (thickness) x 90 (width) mm
Cylindrical objects = Ø 6 mm

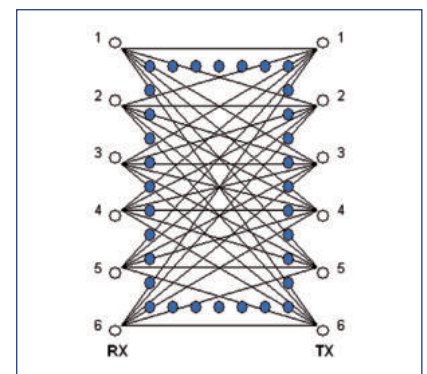

Scan mode 3-4:
low speed / high resolution
Minimum object detection
Flat = 0.2 (thickness) x 75 (width) mm
Cylindrical objects = Ø 6 mm

STANDARD RESOLUTION SCANNING MODE

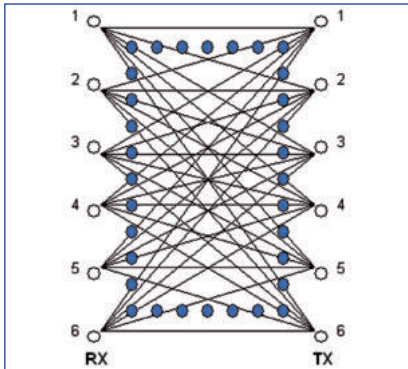

Note: the scan mode is fixed in the standard resolution version.

Minimum object detection
 Flat = 0.2 (thickness) x 200 (width) mm
 Cylindrical objects = Ø 18 mm

MODEL SELECTION AND ORDER INFORMATION

MODEL	DISTANCE	RESOLUTION	CONTROLLED HEIGHT	ADJUSTMENT TRIMMER
AS1-LD-HR-010-J	0.3 – 2.1m	high	100mm	
AS1-LD-HR-P	0.3 – 2.1m	high	100mm	•
AS1-LD-SR-010-J	0.3 – 2.1m	standard	100mm	
AS1-LD-SR-P	0.3 – 2.1m	standard	100mm	•
AS1-HD-HR-010-J	0.8 – 3m	high	100mm	
AS1-HD-SR-010-J	0.8 – 3m	standard	100mm	

Fixing brackets and screws are supplied in the package

ACCESSORY SELECTION AND ORDER INFORMATION

MODEL	DESCRIPTION
M12-5,0-Z-5	Connector axial M12, 5-pole, 5m
M12-10,0-Z-5	Connector axial M12, 5-pole, 10m
M12-5,0-Z-4	Connector axial M12, 4-pole, 5m
M12-10,0-Z-4	Connector axial M12, 4-pole, 10m



The company endeavours to continuously improve and renew its products; for this reason the technical data and contents of this catalogue may undergo variations without prior notice. For correct installation and use, the company can guarantee only the data indicated in the instruction manual supplied with the products.

